

Datasheet

250 meters Long-Range PoE Switch for CCTV

WI-PS205 | WI-PS210 | WI-PS210G | WI-PS518G
WI-PS526G

Hardware Version 4.0



Overview

Complied with 802.3af/at/bt(Hi-PoE), Wi-Tek Long-Distance PoE Switch provide 4/8/16/24 10/100Mbps PoE RJ-45 ports, which can meet flexibly the demand of different PoE Input in different application scenarios. In addition, Wi-Tek Long-Distance PoE Switch can extend the data transmission distance to 250m, breaking the distance limit and improving the device availability. At the same time, Wi-Tek Long-Distance PoE Switch provide valuable features such as extend mode, PoE Watchdog, Port isolation, creating reliable network to grow your business.

Features

PoE 250m Long Distance to Extend Network

DIP switch provides Extend Mode. All PoE ports can transmit data and power up to 250 meters. No additional hardware or configuration is required, making it user-friendly and cost-effective. Perfect for surveillance camera deployment in large areas.

Hi-PoE 60W Design for Higher Power PoE Devices

Hi-PoE switch is the upgraded version of PoE switch with higher PoE power. There are many emerging applications that take advantage of high-power PoE, such as building infrastructure with LED display, PTZ IP cameras, and other high power consumption devices.

Smart PoE Watchdog to Reboot Camera Automatically

Watchdog is able to monitor status of camera in real-time. Once the camera stops working and does not respond to the switch, the switch will reboot the camera, making surveillance management easier.

CCTV Mode Provide QoS Function

To ensure your network operates stably at peak performance, QoS is designed to assign priority to critical data on your network. To make it even easier, Wi-Tek's unmanaged switches include a DIP switch that can enable QoS with a simple switch flip.

Port Isolation to Prevent Broadcast Storm

With VLAN Mode, all PoE ports only can communicate with uplink ports. Avoid data leakage between each port and prevent broadcast storm from disabling network.

Specifications



Model	WI-PS205	WI-PS210	WI-PS210G
Hardware Specifications			
Hardware Version	V4	V4	V4
Interfaces			
Downlink Ports	4 10/100Mbps RJ45 PoE Ports	8 10/100Mbps RJ45 PoE Ports	8 10/100Mbps RJ45 PoE Ports
Uplink Ports	2 10/100Mbps Uplink Ports	2 10/100Mbps Uplink Ports	2 100/1000Mbps Uplink Ports
PoE			
PoE Port	Port 1–4	Port 1–8	
PoE Standard	Port 1: 802.3bt 60W Port 2–4: 802.3af/at 30W	Port 1: 802.3bt 60W Port 2–8: 802.3af/at 30W	
PoE Power Supply Type	Mid-span and End-span		
PoE Pin Assignment	1/2(+), 3/6(-) or 4/5(+), 7/8(-)		
PoE Power	60 W max for port 1, 30W max for port 2–4, 60 W Max. (PoE power budget)	60 W max for port 1, 30W max for port 2–8, 120 W Max. (PoE power budget)	60 W max for port 1, 30W max for port 2–8, 120 W Max. (PoE power budget)
Switch Property			
Standards and Protocols	IEEE 802.3 (Ethernet) IEEE 802.3u (Fast Ethernet) IEEE 802.3ab (Gigabit Ethernet) IEEE 802.3af (Power over Ethernet) IEEE 802.3at (Power over Ethernet Plus) IEEE 802.3bt (Power over Ethernet Type 3)		
Forwarding Mode	Store and Forward		
Switching Capacity	1.2 Gbps	2 Gbps	5.6Gbps
Packet Forwarding Rate	0.89Mpps	1.49Mpps	4.17Mpps
MAC Address Table	2k	1k	8k
Packet Buffer Memory	448 K bit		4Mbit
Jumbo Frame	1536Byte		9216Byte
Power Supply			
Input Power	DC 48–56V 1.3A Max	DC 48–56V 2.5A Max	AC 100–240V, 50/60Hz 2.5A Max
Power Consumption	Idle: 2W 100% Traffic Rate with PoE: 62 W	Idle: 3W 100% Traffic Rate with PoE: 123W	Idle: 3W 100% Traffic Rate with PoE: 123W



Model	WI-PS205	WI-PS210	WI-PS210G
Physical Characteristics			
LED Indicators	<p>PWR Solid on: The device power on is normal Off: The device is power off or failed</p> <p>PoE On: PoE is working Off: PoE not working</p> <p>Link On: Data on TX/RX Off: Ports link down PoE Max When total PoE output power > Power Budget * 80%, the LED light will be on</p>		<p>PWR Solid on: The device power on is normal Off: The device is power off or failed</p> <p>PoE On: PoE is working Off: PoE not working</p> <p>LNK/ACT On: Data on TX/RX Off: Ports link down</p>
Buttons	<p>Default The transmission distance of PoE Port can be up to 100m with 100Mbps and disable port VLAN, QoS, Watchdog</p> <p>VLAN Enable Port VLAN and Watchdog, each PoE port just can send data to Up-link port , PoE transmit 100 meters and disable QoS</p> <p>CCTV=250m PoE+VLAN+QoS Enable Port VLAN, PoE transmit 250 meters and enable QoS, Watchdog</p>		
Fan Quantity	Fanless		
Switch Dimensions	140.0x76.7x27.7 mm	168.0x94.0x32.0 mm	220.0x150.0x44 mm
Package Dimensions	193.0x203.0x62.0 mm	195.0x201.0x62.0 mm	315.0x202.0x82.0 mm
Weight	Net Weight: 0.32 kg	Package Weight: 0.47 kg	Net Weight: 1.75 kg
	Package Weight: 0.60 kg	Net Weight: 0.77 kg	Package Weight: 2.37 kg
Installation	Wall-mounted, Desktop		Wall-mounted, Desktop, Rack-mount
Environmental			
Reliability	Surge Immunity	IEC 61000-4-5 Common mode 4kV Differential mode 2kV	
Reliability	ESD Protection	IEC 61000-4-2 Contact discharge 6kV Air discharge 8kV	
Operating Temperature	-10°C-50°C (14°F-122°F)		
Storage Temperature	-40°C-70°C (-40°F-158°F)		
Operating Humidity	10-90% RH non-condensing		
Storage Humidity	5-95% RH non-condensing		
Certification			
Certification	CE, FCC, RoHS, UKCA, RCM		



Model	WI-PS518G	WI-PS526G
Hardware Specifications		
Hardware Version	V4	V4
Interfaces		
Downlink Ports	16 10/100Mbps RJ45 PoE Ports	24 10/100Mbps RJ45 PoE Ports
Uplink Ports	1*1000M Combo SFP Port 1*1000Mbps Ethernet Port	2*1000M Combo SFP Ports
PoE		
PoE Port	Port 1-16	Port 1-24
PoE Standard	Port 1-2: 802.3bt 60W Port 3-16:802.3af/at 30W	Port 1-2: 802.3bt 60W Port 3-24:802.3af/at 30W
PoE Power Supply Type	Mid-span and End-span	
PoE Pin Assignment	1/2(+), 3/6(-) or 4/5(+), 7/8(-)	
PoE Power	60W Max. for port1-2, 30 W for port3-16, 185 W Max. for PoE power budget	60 W Max. for port1-2, 30 W for port 3-24, 250 W Max. for PoE power budget
Switch Property		
Standards and Protocols	IEEE 802.3 (Ethernet) IEEE 802.3u (Fast Ethernet) IEEE 802.3ab (Gigabit Ethernet) IEEE 802.3af (Power over Ethernet) IEEE 802.3at (Power over Ethernet Plus) IEEE 802.3bt (Power over Ethernet Type 3)	
Forwarding Mode	Store and Forward	
Switching Capacity	7.2 Gbps	8.8 Gbps
Packet Forwarding Rate	5.4 Mpps	6.5 Mpps
MAC Address Table	8 k	
Packet Buffer Memory	4Mbit	
Jumbo Frame	9216Byte	
Power Supply		
Input Power	AC:100-240V~50/60Hz 5A Max	
Power Consumption	Idle: 5 W 100% Traffic Rate with PoE: 190 W	Idle: 8 W 100% Traffic Rate with PoE: 258 W



Model	WI-PS518G	WI-PS526G
Physical Characteristics		
LED Indicators	<p>PWR Solid on: The device power on is normal Off: The device is power off or failed</p> <p>PoE On: PoE is working Off: PoE not working</p> <p>LNK/ACT On: Data on TX/RX Off: Ports link down</p> <p>PoE Max When total PoE output power > Power Budget * 80%, the LED light will be on</p> <p>17T/17S On:Port 17T/17S link up Off:Port 17T/17S link down</p> <p>18T On:Port 18T link up Off:Port 18T link down</p>	<p>PWR Solid on: The device power on is normal Off: The device is power off or failed</p> <p>PoE On: PoE is working Off: PoE not working</p> <p>LNK/ACT On: Data on TX/RX Off: Ports link down</p> <p>25T/S(LNK/ACT) On:Port 25T/S link up Off:Port 25T/S link down</p> <p>25T/S(Speed) On: The negotiate speed is 1000Mbps and ports link up Off: The negotiate speed is 10/100Mbps, not 1000Mbps</p> <p>26T/S(LNK/ACT) On:Port 26T/S link up Off:Port 26T/S link down</p> <p>26T/S(Speed) On: The negotiate speed is 1000Mbps and ports link up Off: The negotiate speed is 10/100Mbps, not 1000Mbps</p>
Buttons	<p>Default The transmission distance of PoE Port can be up to 100m with 100Mbps and disable port VLAN, QoS, Watchdog</p> <p>VLAN Enable Port VLAN and Watchdog, each PoE port just can send data to Up-link port , PoE transmit 100 meters and disable QoS</p> <p>CCTV=250m PoE+VLAN+QoS Enable Port VLAN, PoE transmit 250 meters and enable QoS, Watchdog</p>	
Fan Quantity	1	2
Switch Dimensions	280.0x180.0x44 mm	440.0x207.0x44 mm
Package Dimensions	375.0x232.0x79.4 mm	492x316.7x72.0 mm
Weight	Net Weight: 1.78 kg	Net Weight: 2.80 kg
	Package Weight: 2.41 kg	Package Weight: 3.45 kg
Installation	Desktop, Rack-mounted	



Model		WI-PS518G	WI-PS526G
Environmental			
Reliability	Surge Immunity	IEC 61000-4-5 Common mode 4kV Differential mode 2kV	
Reliability	ESD Protection	IEC 61000-4-2 Contact discharge 6 kV Air discharge 8 kV	
Operating Temperature	-10°C-50°C (14°F-122°F)		
Storage Temperature	-40°C-70°C (-40°F-158°F)		
Operating Humidity	10-90% RH non-condensing		
Storage Humidity	5-95% RH non-condensing		
Certification			
Certification	CE, FCC, RoHS, UKCA, RCM		

Appearances and Dimensions

WI-PS205

Dimensions (mm)

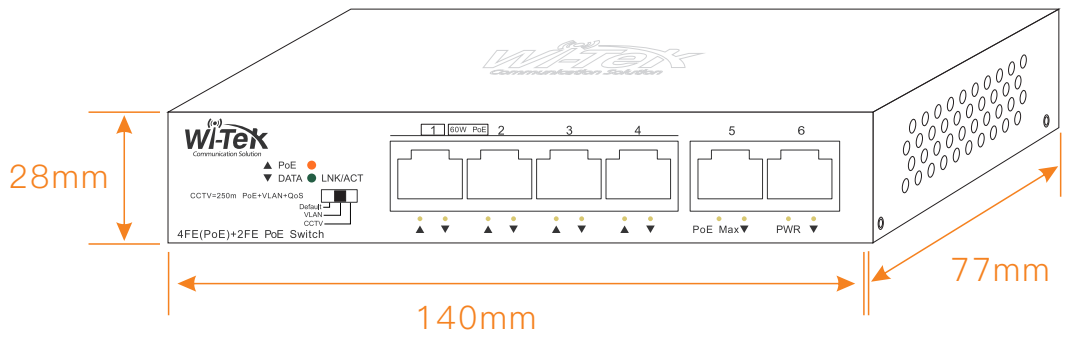

Front Panel

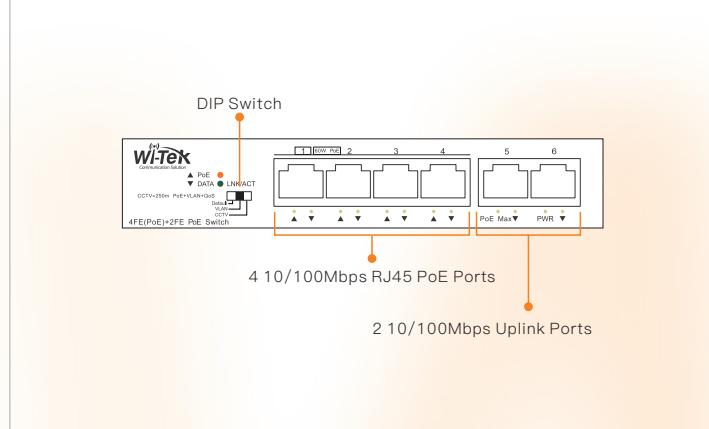

Rear Panel

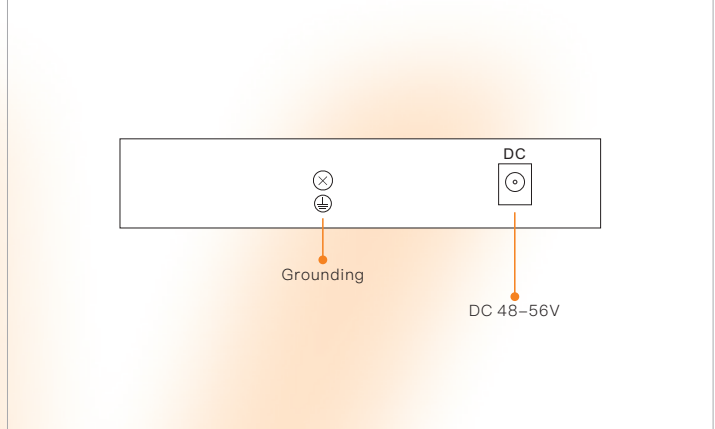

WI-PS210

Dimensions (mm)

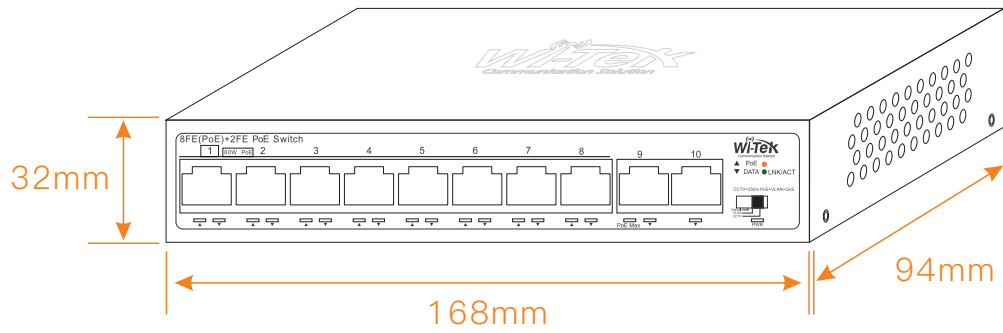

Front Panel

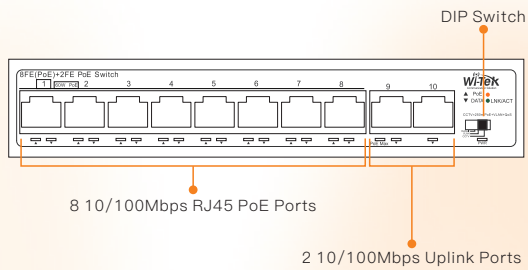

Rear Panel

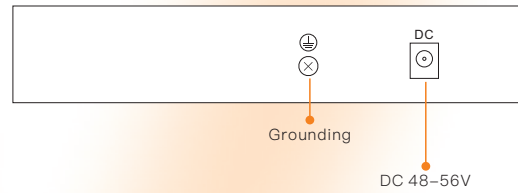

WI-PS210G

Dimensions (mm)

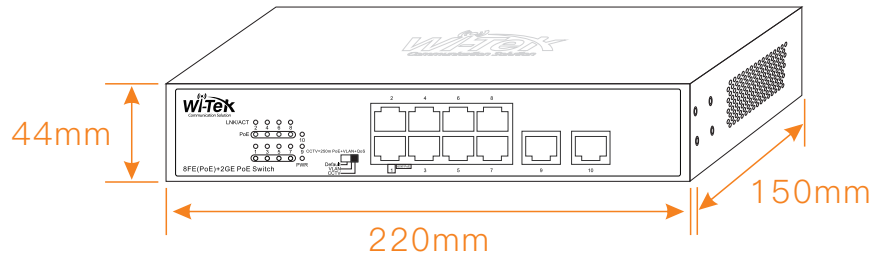

Front Panel

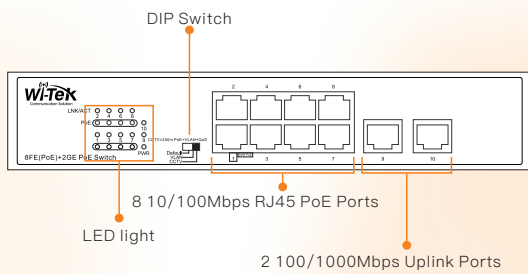

Rear Panel

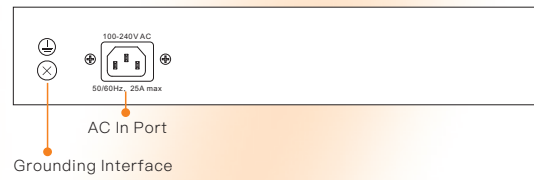

WI-PS518G

Dimensions (mm)

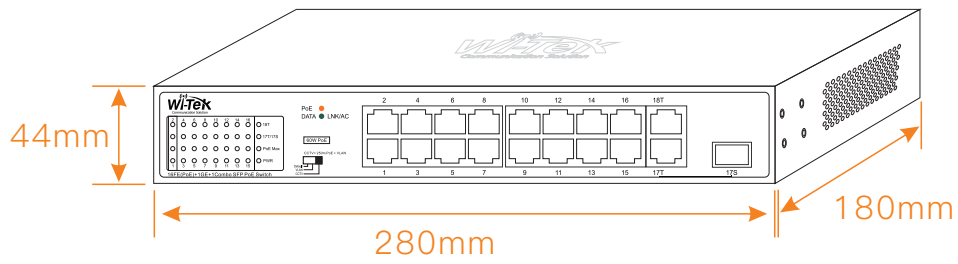

Front Panel

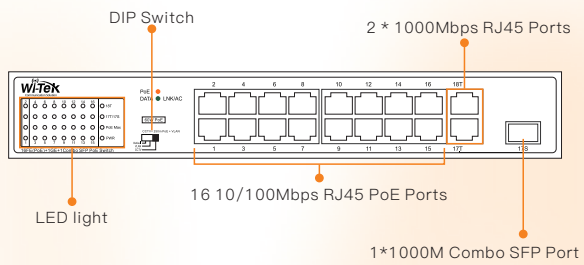

Rear Panel

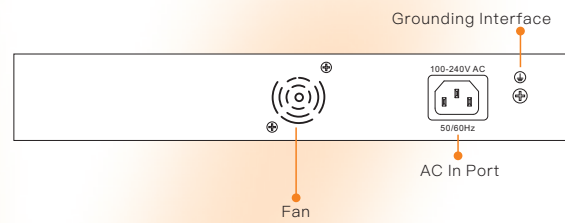

WI-PS526G

Dimensions (mm)

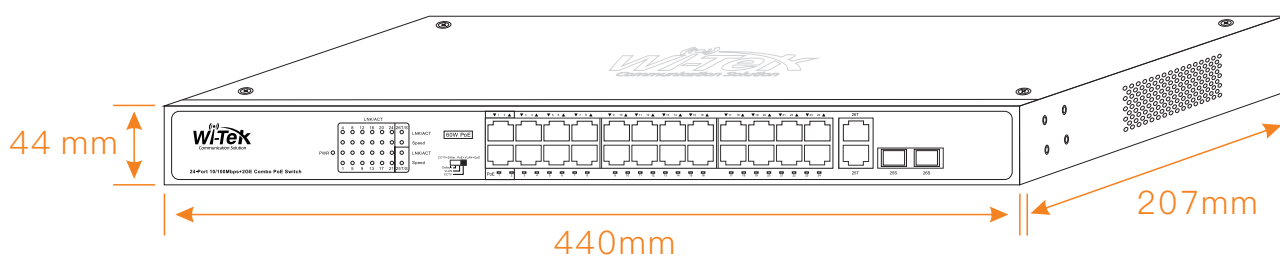

Front Panel

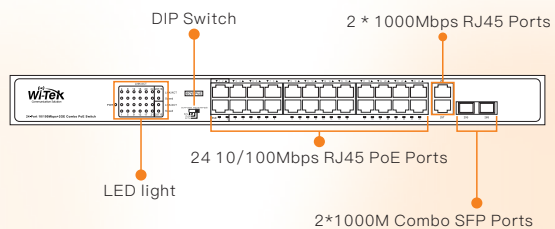

Rear Panel

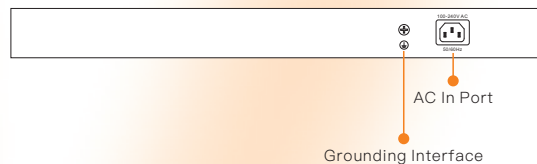

Package Contents

Welcome to order our products. After purchasing, you will receive:

WI-PS205 WI-PS210 WI-PS210G	
Items	Quantity
Switch	1 pcs
Power Cord	1 pcs
Power Adapter	1 pcs
Quick Installation Guide	1 pcs

WI-PS518G WI-PSPS526G	
Items	Quantity
Switch	1 pcs
Power Cord	1 pcs
Rack Mount kit (Hooks × 2; Mats × 4; Screws × 8)	1 pcs
Quick Installation Guide	4 pcs



Wireless-Tek Technology Limited
 Address: Biaofan Technology Building 402, Bao'an street,
 Baoan District, Shenzhen City, Guangdong, China
 Website: www.wireless-tek.com
 Tel: 86-0755-32811290
 Email: sales@wireless-tek.com
 Technical Support: tech@wireless-tek.com



Technical Support



Cloud Management



Company Website